

SPAZZ-G

ORDER FORM 2022

Tel: 951-808-9131 FAX: 951-808-9949
Toll Free: 800-892-8998 www.colourswheelchair.com

DEALER		COLOURS INFORMATION For Office Use Only	
Dealer:		Order Date:	S/N:
Account:	P.O.#:		
Ordered By:			
Customer Name:			
Customer Weight:			

CHAIR INFORMATION	PRICE
SPAZZ-G K0005	Base Wheel Chair Price K0005 \$ 1,829
Adjustable FSH-RSH	Total Section A \$
Max. Capacity 250Lbs	Total Section B \$
NOTE	Total Section C \$
Spazz-G is the economical solution when you want to grow your Chair by changing the seat depth and width after ordering.	Total Section D \$
Main Frame : ZK55 & ZK60 High Grade A7000 Series Aluminum	Total Section E \$
Main Frame : Lifetime Warranty(5 YEARS)	Total Section F \$
	ORDER GRAND TOTAL \$

A FRAME COLORS & PARTS COLORS

FRAME COLORS- Powder-Coated								
<input type="checkbox"/> Gloss Black	<input type="checkbox"/> Twilight Flake	<input type="checkbox"/> Yellow	<input type="checkbox"/> Magenta	<input type="checkbox"/> Fire Engine Red	<input type="checkbox"/> White			\$ STD
<input type="checkbox"/> Neon Yellow	<input type="checkbox"/> Candy Blue	<input type="checkbox"/> Candy Purple	<input type="checkbox"/> Candy Green	<input type="checkbox"/> Candy Red	<input type="checkbox"/> Candy Raspberry	<input type="checkbox"/> Cobalt Blue		
<input type="checkbox"/> Brass Metallic	<input type="checkbox"/> Matte Gray	<input type="checkbox"/> Matte Purple	<input type="checkbox"/> Matte Blue	<input type="checkbox"/> Matte Green	<input type="checkbox"/> Matte Black	<input type="checkbox"/> Matte Red		
<input type="checkbox"/> Tiffany Blue	<input type="checkbox"/> Neon Red	<input type="checkbox"/> Neon Green	<input type="checkbox"/> Orange Sparkle	<input type="checkbox"/> Mellon Yellow	<input type="checkbox"/> Gun Smoke Silver	<input type="checkbox"/> Shocker Yellow		
	<input type="checkbox"/> Sparkle Burgundy	<input type="checkbox"/> Granny Sparkle Green	<input type="checkbox"/> Sparkle Sky Blue	<input type="checkbox"/> Reed Green	<input type="checkbox"/> Blue Lilac			
Special Colors	<input type="checkbox"/> Polished Aluminum-.....							\$ 920
	<input type="checkbox"/> 24 karat Gold Plated							\$ CFP
PARTS COLORS								
STD Color	Black Color (*Suspension Springs-Silver Color Only)-							\$ STD
Custom Color Main Bolt on Parts One Color Package								
Including:	Backrest, Foot Plate, Footrest Rings, Backrest Brackets, Saddle Stops,							<input type="checkbox"/> Powder-Coated ().. \$ 575
	Forks & Knurl Nuts, Caps, Front Suspension Springs, Axle Tube, Axle Clamps, Axle Plates,							<input type="checkbox"/> Polished \$ 863
	Axle Bases, Camber Discs, Caster Housings ☆marked parts							<input type="checkbox"/> 24 karat Gold Plated..... \$ CFP

B FRAME MEASUREMENTS 1/2

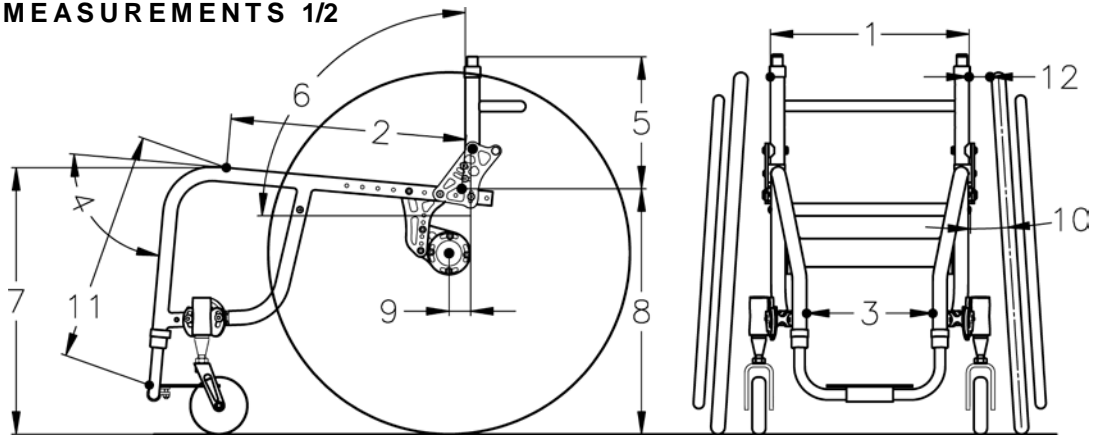

1. SEAT WIDTH	<input type="checkbox"/> 14" <input type="checkbox"/> 15" <input type="checkbox"/> 16" <input type="checkbox"/> 17" <input type="checkbox"/> 18" 	\$ STD
	<input type="checkbox"/> 19" <input type="checkbox"/> 20" 	\$ 327

2. SEAT DEPTH	Depth Adj. Frame <input type="checkbox"/> Short Frame (16" Depth) Set at <input type="checkbox"/> 13" <input type="checkbox"/> 14" <input type="checkbox"/> 15" <input type="checkbox"/> 16" 	\$ STD
	<input type="checkbox"/> Long Frame (19" Depth) Set at <input type="checkbox"/> 15" <input type="checkbox"/> 16" <input type="checkbox"/> 17" <input type="checkbox"/> 18" <input type="checkbox"/> 19"	\$ STD

	<input type="checkbox"/> Aluminum Seat Pan E2231	\$ 282
--	---	--------

3. FOOTREST WIDTH	<input type="checkbox"/> STD (Seat Width Minus 5", Taper on Bottom Frame) 	\$ STD
--------------------------	---	--------

*No Custom Modifications

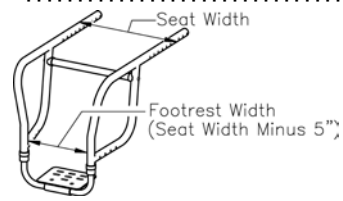

FOOT PLATE STYLE	<input type="checkbox"/> Standard single loop with adjust. height & angle. STD Foot Plate 	K0040 \$ STD
	<input type="checkbox"/> Single Flip-Back-single loop (no riser avail) with adjust. height & angle. STD Foot Plate 	K0040 \$ 173

STD Foot Plate Size Chart

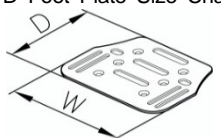

Your Seat Width	Foot Plate Size
14"-15"	W6.5"xD5"
16"-18"	W8.5"xD6.5"
19"-20"	W11"xD6.5"

*No Custom Modifications

Foot Propel w/ Bolt On Stabilizer Bar Style
(\$250 up charge)

Dual Flip Up Footrest w/ Bolt On Stabilizer Bar Style
(\$250 up charge)

4. FRAME BEND ANGLE	<input type="checkbox"/> 90° only 	\$ STD
----------------------------	--	--------

*No Custom Modifications

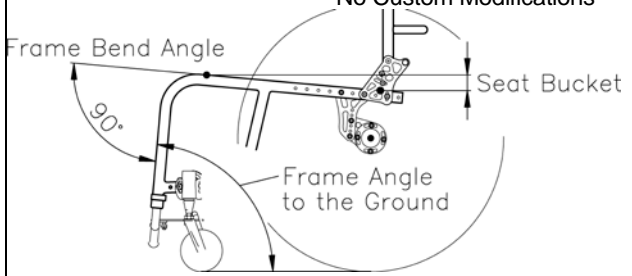

FRAME ANGLE to the Ground

		Your Seat Depth							
		13"	14"	15"	16"	17"	18"	19"	20"
Seat Bucket	0"	90°	90°	90°	90°	90°	90°	90°	90°
	1"	86°	86°	86°	86°	87°	87°	87°	87°
	2"	81°	82°	82°	83°	83°	84°	84°	84°
	3"	77°	78°	78°	79°	80°	80°	81°	81°
	4"	72°	73°	75°	76°	76°	77°	78°	78°
	5"	67°	69°	71°	72°	73°	74°	75°	76°

B FRAME MEASUREMENTS 2/2

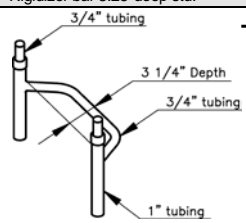
5. BACKREST HEIGHT <small>* Rigidizer bar 3.25" deep std.</small>	<input type="checkbox"/> 8" <input type="checkbox"/> 9" <input type="checkbox"/> 10" <input type="checkbox"/> 11" <input type="checkbox"/> 12" <input type="checkbox"/> 13" <input type="checkbox"/> 14" <input type="checkbox"/> 15" <input type="checkbox"/> 16" <input type="checkbox"/> 17" <input type="checkbox"/> 18"	Adj. Range <input type="checkbox"/> 8" <input type="checkbox"/> 9" <input type="checkbox"/> 10" <input type="checkbox"/> 11" <input type="checkbox"/> 12" <input type="checkbox"/> 13" <input type="checkbox"/> 14" <input type="checkbox"/> 15" <input type="checkbox"/> 16" <input type="checkbox"/> 17" <input type="checkbox"/> 18"	\$ STD																																																																																																					
	Type																																																																																																							
<input type="checkbox"/> Locking mechanism with adjust. height & angle		\$ STD																																																																																																						
<input type="checkbox"/> Double Locking mechanism with adjust. height & angle		\$ 29																																																																																																						
<input type="checkbox"/> Folding with adjust. height & angle		\$ NCO																																																																																																						
<small>*No Custom Modifications</small>																																																																																																								
6. BACKREST ANGLE	Set at (°) to the ground <small>*STD 90°</small>			\$ STD																																																																																																				
7. FRONT SEAT HEIGHT	<input type="checkbox"/> 17.5" <input type="checkbox"/> 18.0" <input type="checkbox"/> 18.5" <input type="checkbox"/> 19.0" <input type="checkbox"/> 19.5" <input type="checkbox"/> 20.0" <input type="checkbox"/> 20.5"			\$ STD																																																																																																				
<small>The front seat heights are impacted by the size of your front caster.</small>																																																																																																								
STD Front Seat Height Ranges <small>*No Custom Modifications</small>	<table border="1" style="width:100%; border-collapse: collapse; text-align: center;"> <tr> <td colspan="2" rowspan="2"></td> <td colspan="7">Front Seat Height</td> </tr> <tr> <td>17.5"</td><td>18.0"</td><td>18.5"</td><td>19.0"</td><td>19.5"</td><td>20.0"</td><td>20.5"</td> </tr> <tr> <td rowspan="9" style="writing-mode: vertical-rl; transform: rotate(180deg);">Your Casters & Forks</td> <td>3" Caster & STD Forks</td> <td><input type="checkbox"/></td><td><input type="checkbox"/></td><td><input type="checkbox"/></td><td><input type="checkbox"/></td><td><input type="checkbox"/></td><td></td><td></td> </tr> <tr> <td>3" Caster & Springs</td> <td></td><td><input type="checkbox"/></td><td><input type="checkbox"/></td><td><input type="checkbox"/></td><td><input type="checkbox"/></td><td></td><td></td> </tr> <tr> <td>3" Caster & Frog Legs</td> <td></td><td></td><td><input type="checkbox"/>*</td><td><input type="checkbox"/>*</td><td><input type="checkbox"/>*</td><td><input type="checkbox"/>*</td><td></td> </tr> <tr> <td>4" Caster & STD Forks</td> <td></td><td><input type="checkbox"/></td><td><input type="checkbox"/></td><td><input type="checkbox"/></td><td><input type="checkbox"/></td><td><input type="checkbox"/></td><td></td> </tr> <tr> <td>4" Caster & Springs</td> <td></td><td><input type="checkbox"/></td><td><input type="checkbox"/></td><td><input type="checkbox"/></td><td><input type="checkbox"/></td><td><input type="checkbox"/></td><td></td> </tr> <tr> <td>4" Caster & Frog Legs</td> <td></td><td></td><td><input type="checkbox"/>*</td><td><input type="checkbox"/>*</td><td><input type="checkbox"/>*</td><td><input type="checkbox"/>*</td><td><input type="checkbox"/>*</td> </tr> <tr> <td>5" Caster & STD Forks</td> <td></td><td></td><td><input type="checkbox"/>*</td><td><input type="checkbox"/></td><td><input type="checkbox"/></td><td><input type="checkbox"/></td><td><input type="checkbox"/>*</td> </tr> <tr> <td>5" Caster & Springs</td> <td></td><td></td><td></td><td><input type="checkbox"/>*</td><td><input type="checkbox"/>*</td><td><input type="checkbox"/>*</td><td><input type="checkbox"/>*</td> </tr> <tr> <td>5" Caster & Frog Legs</td> <td></td><td></td><td></td><td><input type="checkbox"/>*</td><td><input type="checkbox"/>*</td><td><input type="checkbox"/>*</td><td><input type="checkbox"/>*</td> </tr> </table>					Front Seat Height							17.5"	18.0"	18.5"	19.0"	19.5"	20.0"	20.5"	Your Casters & Forks	3" Caster & STD Forks	<input type="checkbox"/>	<input type="checkbox"/>	<input type="checkbox"/>	<input type="checkbox"/>	<input type="checkbox"/>			3" Caster & Springs		<input type="checkbox"/>	<input type="checkbox"/>	<input type="checkbox"/>	<input type="checkbox"/>			3" Caster & Frog Legs			<input type="checkbox"/> *	<input type="checkbox"/> *	<input type="checkbox"/> *	<input type="checkbox"/> *		4" Caster & STD Forks		<input type="checkbox"/>	<input type="checkbox"/>	<input type="checkbox"/>	<input type="checkbox"/>	<input type="checkbox"/>		4" Caster & Springs		<input type="checkbox"/>	<input type="checkbox"/>	<input type="checkbox"/>	<input type="checkbox"/>	<input type="checkbox"/>		4" Caster & Frog Legs			<input type="checkbox"/> *	<input type="checkbox"/> *	<input type="checkbox"/> *	<input type="checkbox"/> *	<input type="checkbox"/> *	5" Caster & STD Forks			<input type="checkbox"/> *	<input type="checkbox"/>	<input type="checkbox"/>	<input type="checkbox"/>	<input type="checkbox"/> *	5" Caster & Springs				<input type="checkbox"/> *	<input type="checkbox"/> *	<input type="checkbox"/> *	<input type="checkbox"/> *	5" Caster & Frog Legs				<input type="checkbox"/> *	<input type="checkbox"/> *	<input type="checkbox"/> *	<input type="checkbox"/> *	<small>*=Not Available with Quick Release Caster Axle.</small>											
		Front Seat Height																																																																																																						
		17.5"	18.0"	18.5"	19.0"	19.5"	20.0"	20.5"																																																																																																
Your Casters & Forks	3" Caster & STD Forks	<input type="checkbox"/>	<input type="checkbox"/>	<input type="checkbox"/>	<input type="checkbox"/>	<input type="checkbox"/>																																																																																																		
	3" Caster & Springs		<input type="checkbox"/>	<input type="checkbox"/>	<input type="checkbox"/>	<input type="checkbox"/>																																																																																																		
	3" Caster & Frog Legs			<input type="checkbox"/> *	<input type="checkbox"/> *	<input type="checkbox"/> *	<input type="checkbox"/> *																																																																																																	
	4" Caster & STD Forks		<input type="checkbox"/>	<input type="checkbox"/>	<input type="checkbox"/>	<input type="checkbox"/>	<input type="checkbox"/>																																																																																																	
	4" Caster & Springs		<input type="checkbox"/>	<input type="checkbox"/>	<input type="checkbox"/>	<input type="checkbox"/>	<input type="checkbox"/>																																																																																																	
	4" Caster & Frog Legs			<input type="checkbox"/> *	<input type="checkbox"/> *	<input type="checkbox"/> *	<input type="checkbox"/> *	<input type="checkbox"/> *																																																																																																
	5" Caster & STD Forks			<input type="checkbox"/> *	<input type="checkbox"/>	<input type="checkbox"/>	<input type="checkbox"/>	<input type="checkbox"/> *																																																																																																
	5" Caster & Springs				<input type="checkbox"/> *	<input type="checkbox"/> *	<input type="checkbox"/> *	<input type="checkbox"/> *																																																																																																
	5" Caster & Frog Legs				<input type="checkbox"/> *	<input type="checkbox"/> *	<input type="checkbox"/> *	<input type="checkbox"/> *																																																																																																
8. REAR SEAT HEIGHT	<input type="checkbox"/> 14.5" <input type="checkbox"/> 15.0" <input type="checkbox"/> 15.5" <input type="checkbox"/> 16.0" <input type="checkbox"/> 16.5" <input type="checkbox"/> 17.0" <input type="checkbox"/> 17.5" <input type="checkbox"/> 18.0" <input type="checkbox"/> 18.5" <input type="checkbox"/> 19.0".....			\$ STD																																																																																																				
STD Rear Seat Height Ranges <small>*No Custom Modifications</small>	<table border="1" style="width:100%; border-collapse: collapse; text-align: center;"> <tr> <td></td> <th>Rear Tire Size</th> <th>Rear Seat Height</th> </tr> <tr> <td></td> <td>24"x1"(540)</td> <td>14.5" - 18.0"</td> </tr> <tr> <td></td> <td>24"x1 3/8"(540)</td> <td>15.0" - 18.0"</td> </tr> <tr> <td></td> <td>25"x1"(559)</td> <td>15.5" - 18.0"</td> </tr> <tr> <td></td> <td>24"x2"(540)</td> <td>15.5" - 18.5"</td> </tr> <tr> <td></td> <td>26"x1"(590)</td> <td>15.5" - 19.0"</td> </tr> <tr> <td></td> <td>25"x1.95"(559)</td> <td>16.0" - 19.0"</td> </tr> </table>				Rear Tire Size	Rear Seat Height		24"x1"(540)	14.5" - 18.0"		24"x1 3/8"(540)	15.0" - 18.0"		25"x1"(559)	15.5" - 18.0"		24"x2"(540)	15.5" - 18.5"		26"x1"(590)	15.5" - 19.0"		25"x1.95"(559)	16.0" - 19.0"																																																																																
	Rear Tire Size	Rear Seat Height																																																																																																						
	24"x1"(540)	14.5" - 18.0"																																																																																																						
	24"x1 3/8"(540)	15.0" - 18.0"																																																																																																						
	25"x1"(559)	15.5" - 18.0"																																																																																																						
	24"x2"(540)	15.5" - 18.5"																																																																																																						
	26"x1"(590)	15.5" - 19.0"																																																																																																						
	25"x1.95"(559)	16.0" - 19.0"																																																																																																						
9. CENTER OF GRAVITY	<input type="checkbox"/> 1.0" <input type="checkbox"/> 1.5" <input type="checkbox"/> 2.0" <input type="checkbox"/> 2.5" <input type="checkbox"/> 3.0" <input type="checkbox"/> 3.5" <input type="checkbox"/> 4.0" <input type="checkbox"/> 4.5" <input type="checkbox"/> 5.0" <input type="checkbox"/> 5.5"			\$ STD																																																																																																				
Center of Gravity Ranges	<table border="1" style="width:100%; border-collapse: collapse; text-align: center;"> <tr> <td colspan="2" rowspan="2"></td> <td colspan="10">Your Center of Gravity</td> </tr> <tr> <td>1.0"</td><td>1.5"</td><td>2.0"</td><td>2.5"</td><td>3.0"</td><td>3.5"</td><td>4.0"</td><td>4.5"</td><td>5.0"</td><td>5.5"</td> </tr> <tr> <td rowspan="7" style="writing-mode: vertical-rl; transform: rotate(180deg);">Your Seat Depth</td> <td>13"</td> <td><input type="checkbox"/></td><td><input type="checkbox"/>★</td><td><input type="checkbox"/>★</td><td></td><td></td><td></td><td></td><td></td><td></td><td></td> </tr> <tr> <td>14"</td> <td><input type="checkbox"/></td><td><input type="checkbox"/></td><td><input type="checkbox"/>★</td><td><input type="checkbox"/>★</td><td></td><td></td><td></td><td></td><td></td><td></td> </tr> <tr> <td>15"</td> <td><input type="checkbox"/></td><td><input type="checkbox"/></td><td><input type="checkbox"/></td><td><input type="checkbox"/></td><td><input type="checkbox"/>★</td><td><input type="checkbox"/>★</td><td></td><td></td><td></td><td></td> </tr> <tr> <td>16"</td> <td><input type="checkbox"/></td><td><input type="checkbox"/></td><td><input type="checkbox"/></td><td><input type="checkbox"/></td><td><input type="checkbox"/></td><td><input type="checkbox"/>★</td><td><input type="checkbox"/>★</td><td></td><td></td><td></td> </tr> <tr> <td>17"</td> <td><input type="checkbox"/>★</td><td><input type="checkbox"/></td><td><input type="checkbox"/></td><td><input type="checkbox"/></td><td><input type="checkbox"/></td><td><input type="checkbox"/></td><td><input type="checkbox"/></td><td><input type="checkbox"/>★</td><td><input type="checkbox"/>★</td><td></td> </tr> <tr> <td>18"</td> <td><input type="checkbox"/>★</td><td><input type="checkbox"/></td><td><input type="checkbox"/></td><td><input type="checkbox"/></td><td><input type="checkbox"/></td><td><input type="checkbox"/></td><td><input type="checkbox"/></td><td><input type="checkbox"/></td><td><input type="checkbox"/></td><td><input type="checkbox"/>★</td> </tr> <tr> <td>19"</td> <td><input type="checkbox"/>★</td><td><input type="checkbox"/>★</td><td><input type="checkbox"/></td><td><input type="checkbox"/></td><td><input type="checkbox"/></td><td><input type="checkbox"/></td><td><input type="checkbox"/></td><td><input type="checkbox"/></td><td><input type="checkbox"/></td><td><input type="checkbox"/></td> </tr> </table>					Your Center of Gravity										1.0"	1.5"	2.0"	2.5"	3.0"	3.5"	4.0"	4.5"	5.0"	5.5"	Your Seat Depth	13"	<input type="checkbox"/>	<input type="checkbox"/> ★	<input type="checkbox"/> ★								14"	<input type="checkbox"/>	<input type="checkbox"/>	<input type="checkbox"/> ★	<input type="checkbox"/> ★							15"	<input type="checkbox"/>	<input type="checkbox"/>	<input type="checkbox"/>	<input type="checkbox"/>	<input type="checkbox"/> ★	<input type="checkbox"/> ★					16"	<input type="checkbox"/>	<input type="checkbox"/>	<input type="checkbox"/>	<input type="checkbox"/>	<input type="checkbox"/>	<input type="checkbox"/> ★	<input type="checkbox"/> ★				17"	<input type="checkbox"/> ★	<input type="checkbox"/>	<input type="checkbox"/>	<input type="checkbox"/>	<input type="checkbox"/>	<input type="checkbox"/>	<input type="checkbox"/>	<input type="checkbox"/> ★	<input type="checkbox"/> ★		18"	<input type="checkbox"/> ★	<input type="checkbox"/>	<input type="checkbox"/>	<input type="checkbox"/>	<input type="checkbox"/>	<input type="checkbox"/>	<input type="checkbox"/>	<input type="checkbox"/>	<input type="checkbox"/>	<input type="checkbox"/> ★	19"	<input type="checkbox"/> ★	<input type="checkbox"/> ★	<input type="checkbox"/>	<input type="checkbox"/>	<input type="checkbox"/>	<input type="checkbox"/>	<input type="checkbox"/>	<input type="checkbox"/>	<input type="checkbox"/>	<input type="checkbox"/>	
		Your Center of Gravity																																																																																																						
		1.0"	1.5"	2.0"	2.5"	3.0"	3.5"	4.0"	4.5"	5.0"	5.5"																																																																																													
Your Seat Depth	13"	<input type="checkbox"/>	<input type="checkbox"/> ★	<input type="checkbox"/> ★																																																																																																				
	14"	<input type="checkbox"/>	<input type="checkbox"/>	<input type="checkbox"/> ★	<input type="checkbox"/> ★																																																																																																			
	15"	<input type="checkbox"/>	<input type="checkbox"/>	<input type="checkbox"/>	<input type="checkbox"/>	<input type="checkbox"/> ★	<input type="checkbox"/> ★																																																																																																	
	16"	<input type="checkbox"/>	<input type="checkbox"/>	<input type="checkbox"/>	<input type="checkbox"/>	<input type="checkbox"/>	<input type="checkbox"/> ★	<input type="checkbox"/> ★																																																																																																
	17"	<input type="checkbox"/> ★	<input type="checkbox"/>	<input type="checkbox"/>	<input type="checkbox"/>	<input type="checkbox"/>	<input type="checkbox"/>	<input type="checkbox"/>	<input type="checkbox"/> ★	<input type="checkbox"/> ★																																																																																														
	18"	<input type="checkbox"/> ★	<input type="checkbox"/>	<input type="checkbox"/>	<input type="checkbox"/>	<input type="checkbox"/>	<input type="checkbox"/>	<input type="checkbox"/>	<input type="checkbox"/>	<input type="checkbox"/>	<input type="checkbox"/> ★																																																																																													
	19"	<input type="checkbox"/> ★	<input type="checkbox"/> ★	<input type="checkbox"/>	<input type="checkbox"/>	<input type="checkbox"/>	<input type="checkbox"/>	<input type="checkbox"/>	<input type="checkbox"/>	<input type="checkbox"/>	<input type="checkbox"/>																																																																																													
<small>★=Not Available Scissor Wheel Lock ★=Excludes 24" x 2", 26" x 1", 25" x 1.95" tires are selected.</small>																																																																																																								
10. CAMBER ANGLE	<input type="checkbox"/> 2° <input type="checkbox"/> 4° <input type="checkbox"/> 6°			\$ STD																																																																																																				
11. FRONT OF SEAT SLING TO FRONT OF FOOTREST	<input type="checkbox"/> 15.0" <input type="checkbox"/> 15.5" <input type="checkbox"/> 16.0" <input type="checkbox"/> 16.5" <input type="checkbox"/> 17.0" <input type="checkbox"/> 17.5" <input type="checkbox"/> 18.0" <input type="checkbox"/> 18.5" <input type="checkbox"/> 19.0" <input type="checkbox"/> 19.5".....			\$ STD																																																																																																				
<small>*Measurement must be 1.5" shorter than your Front Seat Height</small>																																																																																																								
HIGH MOUNT <small>With Risers or Clamps</small>	<input type="checkbox"/> 9.5" <input type="checkbox"/> 10.0" <input type="checkbox"/> 10.5" <input type="checkbox"/> 11.0" <input type="checkbox"/> 11.5" <input type="checkbox"/> 12.0" <input type="checkbox"/> 12.5" <input type="checkbox"/> 13.0" <input type="checkbox"/> 13.5" <input type="checkbox"/> 14.0" <input type="checkbox"/> 14.5"			\$ 75																																																																																																				
12. INSIDE WHEEL CLEARANCE	<input type="checkbox"/> 3/4" * <input type="checkbox"/> 1" <input type="checkbox"/> 1 1/4" <input type="checkbox"/> 1 1/2" <input type="checkbox"/> 1 3/4" <input type="checkbox"/> 2"			\$ STD																																																																																																				
<small>*3/4" Inside wheel clearance not available with 2 degree camber. (with the exception of Y-360 wheels) *3/4" Inside wheel clearance not available with armrest.</small>																																																																																																								
NOTE																																																																																																								

1. SEAT WIDTH

Measure from outside of seat tube to the outside of the opposite seat tube.

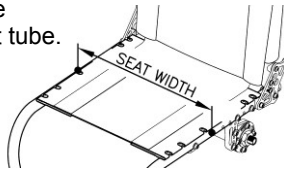

2. SEAT DEPTH

Measure from at the front bottom of backrest tube to the front edge of seat sling.

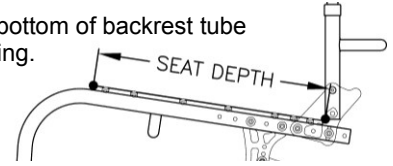

3. FOOTREST WIDTH

Measure from inside of front frame tube to inside of opposite front frame tube.

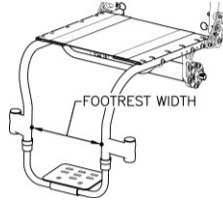

4. FRAME ANGLE

Measure angle frame front to floor.

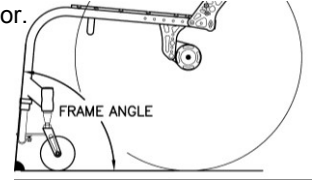

5. BACKREST HEIGHT

Measure from top of back post to seat sling at front bottom of backrest tube.

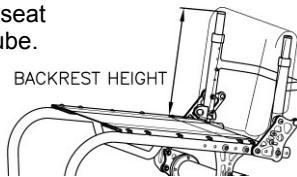

6. BACKREST ANGLE

Measure angle from front of back post to floor.

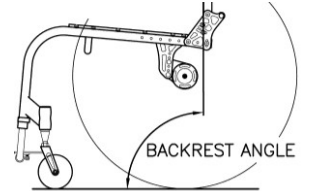

7. FRONT SEAT HEIGHT

Measure from floor to top of seat sling at front edge.

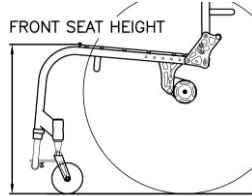

8. REAR SEAT HEIGHT

Measure from floor to top of seat sling at front bottom of backrest tube.

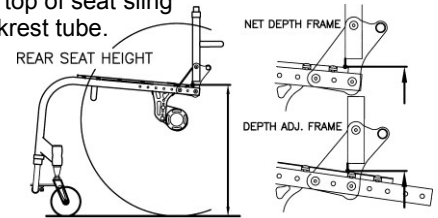

9. CENTER OF GRAVITY

Measure from center of back tube at the folding pivot to the center of the rear axle.

(If welding backrest is selected, Measure from center of back tube at the seat tube to the center of the rear axle.)

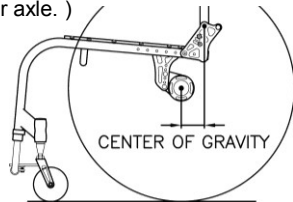

10. CAMBER ANGLE

Measure angle from wheel to vertical at floor.

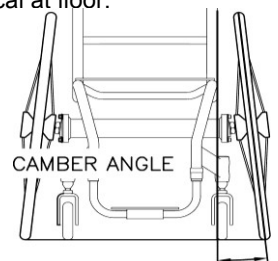

11. FRONT OF SEAT SLING TO FOOTREST

ADULT CHAIR

Measure from top of seat sling at front edge to top of foot plate at front edge.

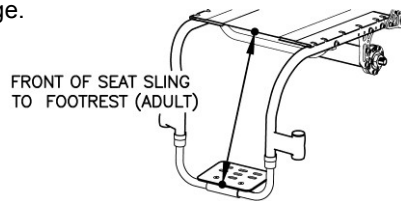

PEDIATRIC CHAIR

Measure vertical from top of seat sling at front edge to top of foot plate.

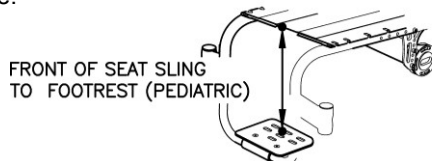

12. INSIDE WHEEL CLEARANCE

Measure from outside of seat back tube to inside of rear tire.

(If side guards are selected, measure from outside of side guards to inside of rear tire.)

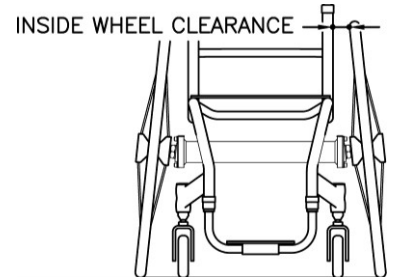

C COMPONENTS

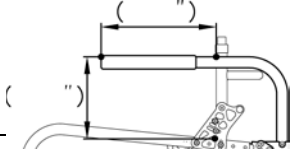
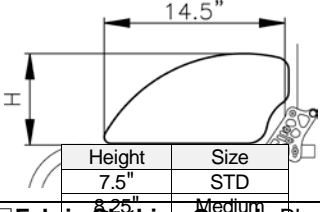
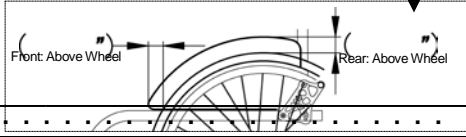
WHEEL LOCKS			
<input type="checkbox"/> Push to Lock / Anodized Black Only <input type="checkbox"/> w/ 2" Extension Handle (\$80up charge).....			
<input type="checkbox"/> Gallop Push to Lock / Anodized			\$ STD
<input type="checkbox"/> Question Mark Style Scissor			\$ 70
<input type="checkbox"/> NEW Compact Scissor Lock / Anodized Black Only			\$ 127
<input type="checkbox"/> Gallop Scissor Lock / Anodized			\$ 127
PUSH HANDLES *If you are ordering push handles, You must select the backrest locking mechanism.			
<input type="checkbox"/> Integrated w/Fixed Backrest Height / Anodized Black Only			\$ STD
<input type="checkbox"/> Bolt-on / Anodized Black Only Specify Height from floor -(")			\$ 163
<input type="checkbox"/> Bolt-on w/Quick Release / Anodized Black Only Specify Height from floor -(")			\$ 219
<input type="checkbox"/> NEW Height Adj. / Anodized Black Only Specify Maximum height from floor -(")			\$ 339
NEW ARM RESTS Anodized Black Only			
<input type="checkbox"/> Fixed Tubular Armrest	Adj. Angle and Height Height from seat sling Set at : <input type="checkbox"/> 8" <input type="checkbox"/> 9" <input type="checkbox"/> 10" <input type="checkbox"/> 11" <input type="checkbox"/> 12" E0973		\$ 288
<input type="checkbox"/> Swing Away Tubular Armrest	Adj. Angle and Height Height from seat sling Set at : <input type="checkbox"/> 8" <input type="checkbox"/> 9" <input type="checkbox"/> 10" <input type="checkbox"/> 11" <input type="checkbox"/> 12" E0973		\$ 288
<input type="checkbox"/> Flip-Up Armrest	<input type="checkbox"/> w/Fixed Tubular Armrest Height from seat sling Set at : <input type="checkbox"/> 8" <input type="checkbox"/> 9" <input type="checkbox"/> 10" <input type="checkbox"/> 11" <input type="checkbox"/> 12" E0973		\$ 288
Adj. Angle <input type="checkbox"/> w/ Swing Away Tubular Armrest	Height from seat sling Set at : <input type="checkbox"/> 8" <input type="checkbox"/> 9" <input type="checkbox"/> 10" <input type="checkbox"/> 11" <input type="checkbox"/> 12" E0973		\$ 288
<input type="checkbox"/> Custom Length & Height (\$173 up charge) *Specify Height & Length →			
ANTI-TIPPERS			
<input type="checkbox"/> Removable Anti-tipper(pair) Anodized Black Only		E0971	\$ 253
<input type="checkbox"/> Press Release Removable Anti-tipper(pair)		E0971	\$ 288
SIDE GUARDS			
<input type="checkbox"/> Rigid Side Guards - Black ABS Color: Black Only	<input type="checkbox"/> Non-Removable <input type="checkbox"/> Removable <input type="checkbox"/> Removable w/Hole (\$12 up charge) Size: <input type="checkbox"/> STD <input type="checkbox"/> Medium <input type="checkbox"/> Cut to Wheel (\$98 up charge) —Measurement		\$ 163
<input type="checkbox"/> Rigid Side Guards - Aluminum 	<input type="checkbox"/> Non-Removable <input type="checkbox"/> Removable Size: <input type="checkbox"/> Medium Only <input type="checkbox"/> Cut to Wheel (\$98 up charge) —Measurement Color <input type="checkbox"/> Black (STD) <input type="checkbox"/> Pol. Aluminum (STD) <input type="checkbox"/> Powder Coated () (\$120 up charge) <input type="checkbox"/> Gold Plate (+CFP)		\$ 227
<input type="checkbox"/> Fabric Clothing Guards Black Nylon w/Velcro			\$ 94
SEAT CUSHION -*Please see section for other cushion choices.-			
<input type="checkbox"/> Foam Cushion w/Nylon Black Cover Thickness <input type="checkbox"/> 1" <input type="checkbox"/> 2" <input type="checkbox"/> 3" <input type="checkbox"/> 4"			\$ CFP
<input type="checkbox"/> Custom Cushion Cover (Std. Foam Cushion Only) —Select Fabric () (\$104 up charge)			
ACCESSORIES			
<input type="checkbox"/> Frame Protectors / Black Leather/Zipper Type			\$ 94
<input type="checkbox"/> Gel Ovation Protector Wraps Gel Silicone			\$ 115
<input type="checkbox"/> E0978 Seat Belt w/Auto Buckle (BP) 1.5" Black Belt Only		E0978	\$ 98
<input type="checkbox"/> Tie Down Brackets 4pcs.			\$ 242
<input type="checkbox"/> Calf Strap <input type="checkbox"/> Black <input type="checkbox"/> Matching Fabric (\$55 up charge) -Select Fabric()			\$ 29
<input type="checkbox"/> Bodypoint Padded Calf Strap <input type="checkbox"/> (14"-16" footrest width) <input type="checkbox"/> (16"-20" footrest width) <input type="checkbox"/> (20"-24" footrest)		\$77 \$83 \$89	
<input type="checkbox"/> Hanging Zipper Pouch <input type="checkbox"/> Black <input type="checkbox"/> Matching Fabric (\$60) or <input type="checkbox"/> Leather (\$75) Custom Size Width: Length:			\$ 75
<input type="checkbox"/> Matching Fabric on Padded Side Guards —Select Fabric ()			\$ 242
UPHOLSTERY CHOICE & COLOR *Positioning Back Available. Please see Section E			
<input type="checkbox"/> Standard Adjustable Height Backrest (Black)			\$ STD
<input type="checkbox"/> Adjustable Tension Backrest Black Only (*Not available with 8" Backrest Height)			\$ 150
Options	<input type="checkbox"/> Fun Fabric: For Std. or Adj. Style (Choose From Choices on Page 6 and write below) (\$ 80 up charge)		
<input type="checkbox"/> Backrest Leather Trim (outside panels)			\$ CFP

FABRIC CHOICE SHEET

1. Camouflage Girls

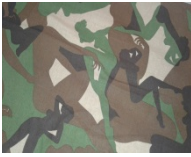

2. Purple Zebra



3. Silver Grey Snake



5. Laughing Skulls



6. Purple Snake



7. Sweetheart Pinup Girls



9. Blue Flames

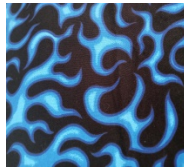

10. Arctic Camo



11. Furry Friends



12. Supercars



13. Urban Camo

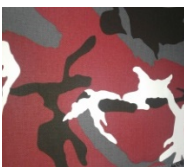

14. Superbikes



15. Sizzle Flames



16. Hot Rod Flames



17. Skulls w/ Attitude

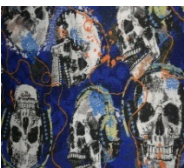

18. Sweet Pink

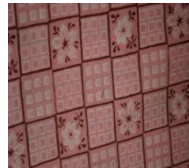

19. Heart and Soul



20. Home Run



21. Fuzzy Giraffe

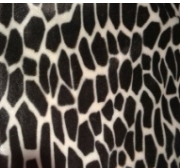

22. Cheetah



23. Paperweight Cobalt



24. Zig Zag Dots



25. Smokey Tribal Flames

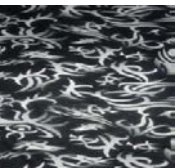

26. Rose and Rebellion



27. Tattoo Adventure(Cream

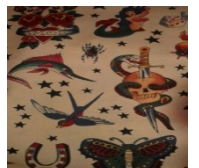

28. Red Tribal Flames

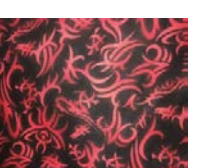

29. Tattoo Adventure(Black)

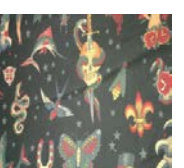

30. Butterfly Bandana

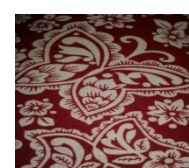

31. Tatsu Dragon

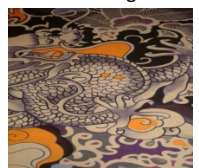

D TIRES, CASTERS, & FORKS



TIRES						
<input type="checkbox"/>	Primo High Pressure Tire <input type="checkbox"/> 24"x1" <input type="checkbox"/> 25"x1" <input type="checkbox"/> 26"x1"	Gray Tire w/ black line	E2211/E2212	\$	STD	
<input type="checkbox"/>	Primo High Pressure Tire <input type="checkbox"/> 24"x1" <input type="checkbox"/> 25"x1" or <input type="checkbox"/> 26"x1"	<input type="checkbox"/> Blue <input type="checkbox"/> Red	E2211/E2212	\$	98	
<input type="checkbox"/>	Low Pressure Tire <input type="checkbox"/> 24"x1-3/8" or <input type="checkbox"/> 26"x1-3/8"	Gray Only	E2211/E2212	\$	STD	
<input type="checkbox"/>	Schwalbe Marathon Plus High Pressure Tire <input type="checkbox"/> 24"x1", <input type="checkbox"/> 25"x1" or <input type="checkbox"/> 26"x1"	Black Only	E2211/E2212	\$	148	
<input type="checkbox"/>	Solid Tire <input type="checkbox"/> 24"x1" <input type="checkbox"/> 25"x1" Black		E2218	\$	190	
<input type="checkbox"/>	Solid Tire <input type="checkbox"/> 26"x1 Dark Grey			\$	155	
<input type="checkbox"/>	Moderate V-Track Knobby Tire 24"x1-3/8" (37-540)	Gray Only	E2211/E2212	\$	135	
<input type="checkbox"/>	Aggressive Knobby Tire 24"x 2" (50-540)	Gray Only <input type="checkbox"/> Blue Line <input type="checkbox"/> Red Line	E2211/E2212	\$	135	
<input type="checkbox"/>	Aggressive Knobby Tire 26"x 2" (50-559)	Gray Only <input type="checkbox"/> Blue Line <input type="checkbox"/> Red Line	E2211/E2212	\$	135	
<input type="checkbox"/>	Aggressive Knobby Tire 24" x 1.95"(50-540)	Black Only	E2211/E2212	\$	135	
<input type="checkbox"/>	E2211 Bell Mountain Bike Tire in Flat Defense (559) 26" X 1.75 - 2.25 Black Only		E2211/E2212	\$	135	
<input type="checkbox"/>	Flat-Free Inserts For 24"x1-3/8" Tires Only		E2211/E2213	\$	135	

CASTERS						
SIZE	TIRE WIDTH	HUB COLOR	TIRE COLOR	DESCRIPTION		
<input type="checkbox"/> 3"	1"	Black Hub	Black Tire Only	Polyurethane	K0077	\$ STD
<input type="checkbox"/> 3"	1"	Plastic Black Hub	Clear Tire Only	Lighted, Polyurethane	A9900	\$ 75
<input type="checkbox"/> 3"	1"	Red Hub	Red Tire Only	Polyurethane	E2222	\$ STD
<input type="checkbox"/> 3"	1"	Black Hub	Clear Tire Only	Polyurethane	E2222	\$ STD
<input type="checkbox"/> 3"	1"	Aluminum Silver Hub	Black Tire Only	Made By Frog Legs	K0071	\$ 190
<input type="checkbox"/> 3"	1"	Aluminum Black Hub	Black Tire Only	Made By Frog Legs	E2222	\$ 190
<input type="checkbox"/> 3"	1.5"	Aluminum Silver Hub	Black Tire Only	Soft Roll Made By Frog Legs	E2222	\$ 190
<input type="checkbox"/> 3"	1.5"	Aluminum Black Hub	Black Tire Only	Soft Roll Made By Frog Legs	E2222	\$ 190
<input type="checkbox"/> 4"	1 1/8"	Plastic Black Hub	Black Tire Only	Polyurethane Not Available with Narrow Frog Leg Forks	E2222	\$ STD
<input type="checkbox"/> 4"	1"	Plastic Black Hub	Clear Only	Lighted, Polyurethane	E2221	\$ 75
<input type="checkbox"/> 4"	1"	Aluminum Silver Hub	Black Tire Only	Made By Frog Legs	E2214	\$ 190
<input type="checkbox"/> 4"	1"	Aluminum Black Hub	Black Tire Only	Made By Frog Legs	E2214	\$ 190
<input type="checkbox"/> 4"	1.5"	Aluminum Silver Hub	Tire <input type="checkbox"/> Black <input type="checkbox"/> Blue <input type="checkbox"/> Red	Soft Roll Made By Frog Legs	E1015	\$ 190
<input type="checkbox"/> 4"	1.5"	Aluminum Black Hub	Black Tire Only	Soft Roll Made By Frog Legs	E2214	\$ 190
<input type="checkbox"/> 5"	1"	Composite Black	Black Tire Only	Polyurethane	E2222	\$ STD
<input type="checkbox"/> 5"	1"	Plastic Black Hub	Clear Tire Only	Lighted, Polyurethane	A9900	\$ 75
<input type="checkbox"/> 5"	1"	Aluminum Silver Hub	Black Tire Only	Made By Frog Legs	A9900	\$ 190
<input type="checkbox"/> 5"	1"	Aluminum Black Hub	Black Tire Only	Made By Frog Legs	E2214	\$ 190
<input type="checkbox"/> 5"	1.5"	Aluminum Silver Hub	Tire <input type="checkbox"/> Black <input type="checkbox"/> Blue <input type="checkbox"/> Red	Soft Roll Made By Frog Legs	K0072	\$ 190
<input type="checkbox"/> 5"	1.5"	Aluminum Black Hub	Black Tire Only	Soft Roll Made By Frog Legs	E2222	\$ 190
<input type="checkbox"/> 6"	1.5"	Aluminum Black Hub	Black Tire Only	Soft Roll Made By Frog Legs	E2222	\$ 213
<input type="checkbox"/> 6"	1.5"	Aluminum Silver Hub	Black Tire Only	Soft Roll Made By Frog Legs	E2222	\$ 213
<input type="checkbox"/> "	<input type="checkbox"/> 1"OR <input type="checkbox"/> 1.5"	Hub Color:	Tread Color:	Soft Roll Made By Frog Legs	E2222	\$ CFP

<input type="checkbox"/>	FORKS	<input type="checkbox"/> Frog Leg Shields(4 pcs) Only for Frog Leg Forks	\$	24
<input type="checkbox"/>	STD Aluminum Forks Black Only		\$	STD
	Extra Options for Aluminum Forks	<input type="checkbox"/> With Suspension Springs	E1015	\$ 63
		<input type="checkbox"/> With Quick Release Axles	K0073	\$ 123
<input type="checkbox"/>	Frog Leg Suspension Forks 1" Wide (For 3", 4" x 1" width Caster and 5" STD Caster, 5" lighted Caster)	Not available with Quick Release Axle	E1015	\$ 552
	*User's Weight _____ Color <input type="checkbox"/> Anodized Black <input type="checkbox"/> Anodized Silver			
<input type="checkbox"/>	Frog Leg Suspension Forks 1.5" Wide (For 3", 4" x 1.5" width Caster and 5" x 1" & 5" x 1.5" Casters)	Not available with Quick Release Axle	E1015	\$ 552
	*User's Weight _____ Color <input type="checkbox"/> Anodized Black <input type="checkbox"/> Anodized Silver			

Valid from 2022 Prices & Specifications Are Subject To Change Without Notice.

E WHEELS

WHEELS																		
Wire Wheels	<input type="checkbox"/> 24" (540) <input type="checkbox"/> 25" (599) <input type="checkbox"/> 26" (590)	\$ NCO \$ 299 \$ 299																
Y-360 Billet Wheels *Max. Capacity 220Lbs *Camber 0-2" max *Not for Sports or Rugged use	<input type="checkbox"/> 25" (559) Style <input type="checkbox"/> Saw Blade	\$ 1,300																
Y-360 Billet Wheels MOD Style *Max. Capacity 220Lbs *Camber 0-2" max *Not for Sports or Rugged use	<input type="checkbox"/> 25" (559) Only Style <input type="checkbox"/> Tribal Sun <input type="checkbox"/> Girls <input type="checkbox"/> Eagle <input type="checkbox"/> Holy Cross Specify Powder Coat Color for Insert Only () *Choose from Frame Colors	\$ 1,550																
Extra Options for <input type="checkbox"/> Powder-Coated Spokes Only () *Choose from Frame Colors (\$250 up charge)																		
Spinergy Spox 18 Spokes 	<input type="checkbox"/> 24" (540) <input type="checkbox"/> 25" (559) <input type="checkbox"/> 26" (590) Spoke Color <input type="checkbox"/> Black <input type="checkbox"/> Red <input type="checkbox"/> Yellow <input type="checkbox"/> Blue <input type="checkbox"/> White With Silver Hub With Black Hub With Black Hub With Black Hub With Black Hub <input type="checkbox"/> Custom Color Spoke Pattern <table border="1" style="display: inline-table; margin-left: 10px;"> <thead> <tr> <th colspan="2"></th> <th>Left Wheel</th> <th>Right Wheel</th> </tr> </thead> <tbody> <tr> <td>Spokes</td> <td>Inside</td> <td></td> <td></td> </tr> <tr> <td>Color</td> <td>Outside</td> <td></td> <td></td> </tr> <tr> <td>Hub Color</td> <td></td> <td><input type="checkbox"/> Black/<input type="checkbox"/> Silver</td> <td><input type="checkbox"/> Black/<input type="checkbox"/> Silver</td> </tr> </tbody> </table>			Left Wheel	Right Wheel	Spokes	Inside			Color	Outside			Hub Color		<input type="checkbox"/> Black/ <input type="checkbox"/> Silver	<input type="checkbox"/> Black/ <input type="checkbox"/> Silver	\$ 907 \$ 1,007
		Left Wheel	Right Wheel															
Spokes	Inside																	
Color	Outside																	
Hub Color		<input type="checkbox"/> Black/ <input type="checkbox"/> Silver	<input type="checkbox"/> Black/ <input type="checkbox"/> Silver															
Spinergy LX 12 Spokes 	<input type="checkbox"/> 24" (540) <input type="checkbox"/> 25" (559) <input type="checkbox"/> 26" (590) Spoke Color <input type="checkbox"/> Black <input type="checkbox"/> Red <input type="checkbox"/> Yellow <input type="checkbox"/> Blue With Silver Hub With Black Hub With Black Hub With Black Hub <input type="checkbox"/> White <input type="checkbox"/> Neon Green <input type="checkbox"/> Pink <input type="checkbox"/> Orange With Black Hub With Black Hub With Black Hub With Black Hub <input type="checkbox"/> Purple With Black Hub <input type="checkbox"/> Custom Color Spoke Pattern <table border="1" style="display: inline-table; margin-left: 10px;"> <thead> <tr> <th colspan="2"></th> <th>Left Wheel</th> <th>Right Wheel</th> </tr> </thead> <tbody> <tr> <td>Spokes</td> <td>Inside</td> <td></td> <td></td> </tr> <tr> <td>Color</td> <td>Outside</td> <td></td> <td></td> </tr> <tr> <td>Hub Color</td> <td></td> <td><input type="checkbox"/> Black/<input type="checkbox"/> Silver</td> <td><input type="checkbox"/> Black/<input type="checkbox"/> Silver</td> </tr> </tbody> </table>			Left Wheel	Right Wheel	Spokes	Inside			Color	Outside			Hub Color		<input type="checkbox"/> Black/ <input type="checkbox"/> Silver	<input type="checkbox"/> Black/ <input type="checkbox"/> Silver	\$ 1,138 \$ 1,238
		Left Wheel	Right Wheel															
Spokes	Inside																	
Color	Outside																	
Hub Color		<input type="checkbox"/> Black/ <input type="checkbox"/> Silver	<input type="checkbox"/> Black/ <input type="checkbox"/> Silver															
Spinergy X-Laced Sport Lite Extreme "XSLX" 24 Spokes 	<input type="checkbox"/> 24" (540) <input type="checkbox"/> 25" (559) <input type="checkbox"/> 26" (590) Spoke Color <input type="checkbox"/> Black <input type="checkbox"/> Red <input type="checkbox"/> Yellow <input type="checkbox"/> Blue With Silver Hub With Black Hub With Black Hub With Black Hub <input type="checkbox"/> White <input type="checkbox"/> Neon Green <input type="checkbox"/> Pink <input type="checkbox"/> Orange <input type="checkbox"/> Purple With Black Hub With Black Hub With Black Hub With Black Hub With Black Hub <input type="checkbox"/> Custom Color Spoke Pattern <table border="1" style="display: inline-table; margin-left: 10px;"> <thead> <tr> <th colspan="2"></th> <th>Left Wheel</th> <th>Right Wheel</th> </tr> </thead> <tbody> <tr> <td>Spokes</td> <td>Inside</td> <td></td> <td></td> </tr> <tr> <td>Color</td> <td>Outside</td> <td></td> <td></td> </tr> <tr> <td>Hub Color</td> <td></td> <td><input type="checkbox"/> Black/<input type="checkbox"/> Silver</td> <td><input type="checkbox"/> Black/<input type="checkbox"/> Silver</td> </tr> </tbody> </table>			Left Wheel	Right Wheel	Spokes	Inside			Color	Outside			Hub Color		<input type="checkbox"/> Black/ <input type="checkbox"/> Silver	<input type="checkbox"/> Black/ <input type="checkbox"/> Silver	\$ 1,100 \$ 1,200
		Left Wheel	Right Wheel															
Spokes	Inside																	
Color	Outside																	
Hub Color		<input type="checkbox"/> Black/ <input type="checkbox"/> Silver	<input type="checkbox"/> Black/ <input type="checkbox"/> Silver															

Valid from 2022 Prices & Specifications Are Subject To Change Without Notice.

Spinergy Sport Lite Extreme "SLX" 24 Spoke



24" (540) 25" (559) 26" (590)
 Spoke Color Black Red Yellow Blue
 With Silver Hub With Black Hub With Black Hub With Black Hub
 White Neon Green Pink Orange Purple
 With Black Hub With Black Hub With Black Hub With Black Hub With Black Hub

Custom Color Spoke Pattern

		Left Wheel	Right Wheel
Spokes	Inside		
	Outside		
Hub Color		<input type="checkbox"/> Black/ <input type="checkbox"/> Silver	<input type="checkbox"/> Black/ <input type="checkbox"/> Silver

\$ 1,060

\$ 1,160

Spinergy Lite Extreme "XLX" X-Laced-12 Spoke



24" (540) 25" (559) 26" (590)
 Spoke Color Black Red Yellow Blue
 With Silver Hub With Black Hub With Black Hub With Black Hub
 White Neon Green Pink Orange Purple
 With Black Hub With Black Hub With Black Hub With Black Hub With Black Hub

Custom Color Spoke Pattern

		Left Wheel	Right Wheel
Spokes	Inside		
	Outside		
Hub Color		<input type="checkbox"/> Black/ <input type="checkbox"/> Silver	<input type="checkbox"/> Black/ <input type="checkbox"/> Silver

\$ 1,100

\$ 1,200

Spinergy Blade "LXL" 18 Spoke



24" (540) 25" (559) 26" (590)
 Spoke Color Black Red Yellow Blue
 With Silver Hub With Black Hub With Black Hub With Black Hub
 White Neon Green Pink Orange Purple
 With Black Hub With Black Hub With Black Hub With Black Hub With Black Hub

Custom Color Spoke Pattern

		Left Wheel	Right Wheel
Spokes	Inside		
	Outside		
Hub Color		<input type="checkbox"/> Black	<input type="checkbox"/> Black

\$ 945

\$ 1,045

HANDRIM

Type	<input type="checkbox"/> Standard For 24", 25" or 26" Wheel Anodized Black	\$ STD
	<input type="checkbox"/> Vinyl Coated For 24", 25" & 26" Wheels Not available with Y-360 Billet Wheels	\$ 180
	<input type="checkbox"/> Spinergy Silver Brushed Anodized For 24", 25" & 26"	\$ 160
	<input type="checkbox"/> Natural Fit For 24", 25" & 26" Wheel	
	<input type="checkbox"/> Standard Grip (Not available with short tabs.) Not available with Y-360 Billet Wheels	\$ 464
	<input type="checkbox"/> Super Grip (Not available with short tabs.) Not available with Y-360 Billet Wheels	\$ 561
	<input type="checkbox"/> Without Thumb Grip (Not available with Y-360 Billet Wheels)	\$ 294
	<input type="checkbox"/> Natural Fit(LT) For 24", 25" & 26" Wheel	
	<input type="checkbox"/> Standard Grip (Not available with short tabs.) Not available with Y-360 Billet Wheels	\$ 547
	<input type="checkbox"/> Super Grip (Not available with short tabs.) Not available with Y-360 Billet Wheels	\$ 614
	<input type="checkbox"/> Without Thumb Grip (Not available with Y-360 Billet Wheels)	\$ 347
	<input type="checkbox"/> The Surge Handrims * Not available with Y-360 Billet Wheels	\$ 481
	<input type="checkbox"/> The Surge Handrims (LT) * Not available with Y-360 Billet Wheels	\$ 524
	<input type="checkbox"/> Spinergy Flex Rim Available only on Spinergy LX & XLX	\$ CFP
	<input type="checkbox"/> The Q-Grip Handrims : anti-slip, latex-free, neoprene coating * Not available with Y-360 Billet Wheels	\$ 472
	<input type="checkbox"/> OMIT HANDRIMS	\$ NCO

TAB LENGTH	<input type="checkbox"/> Long Tab (STD inside clearance 3/4") Not available with Y-360 Billet Wheels *	STD
	<input type="checkbox"/> Short Tab (Inside clearance 1/2") * Not available with Natural Fit Handrim with thumb grip	\$ STD
	<input type="checkbox"/> Short Tab (Set closest to wheel cut off excess) * Not available with Y-360 wheel	\$ 30

E CHAIR OPTIONS 1 / 3

SEAT CUSHION							
SUPRACOR® WHEELCHAIR CUSHIONS							
Stimulite® Contoured Cushion *Black Upholstery only *Comes with Zipper Pouch <input type="checkbox"/> Extra Sensitive (\$35 up charge) <input type="checkbox"/> Sling Style Bottom (\$52 up charge) <input type="checkbox"/> Custom Size (\$- CFP) W(") x D(") <input type="checkbox"/> Extra Cover (\$104 up charge)	<input type="checkbox"/> W14"xD16" (CD1416)	E2603 \$ 615				
	<input type="checkbox"/> W16"xD16" (CD1616)	E2603 \$ 615				
	<input type="checkbox"/> W16"xD18" (CD1618)	E2603 \$ 615				
	<input type="checkbox"/> W18"xD16" (CD1816)	E2603 \$ 615				
	<input type="checkbox"/> W18"xD18" (CD1818)	E2603 \$ 615				
	<input type="checkbox"/> W18"xD20" (CD1820)	E2603 \$ 621				
	<input type="checkbox"/> W20"xD16" (CD2016)	E2603 \$ 621				
	<input type="checkbox"/> W20"xD18" (CD2018)	E2603 \$ 621				
	<input type="checkbox"/> W20"xD20" (CD2020)	E2603 \$ 638				
	Stimulite® Slimline Cushion *Black Upholstery only <input type="checkbox"/> Extra Sensitive (\$35 up charge) <input type="checkbox"/> Sling Style Bottom (\$52 up charge) <input type="checkbox"/> Custom Size (\$- CFP) W(") x D(") <input type="checkbox"/> Extra Cover (\$75 up charge)	<input type="checkbox"/> W14"xD16" (SM1416)	E2603 \$ 388			
<input type="checkbox"/> W16"xD16" (SM1616)		E2603 \$ 388				
<input type="checkbox"/> W16"xD18" (SM1618)		E2603 \$ 388				
<input type="checkbox"/> W18"xD18" (SM1818)		E2603 \$ 388				
<input type="checkbox"/> W18"xD20" (SM1820)		E2603 \$ 426				
<input type="checkbox"/> W20"xD16" (SM2016)		E2603 \$ 426				
<input type="checkbox"/> W20"xD18" (SM2018)		E2603 \$ 426				
<input type="checkbox"/> W20"xD20" (SM2020)		E2603 \$ 450				
Stimulite® Corbee Pediatric *Black Upholstery only <input type="checkbox"/> Extra Cover (\$75 up charge)	<input type="checkbox"/> W10"xD10" (PD1010)	E2603 \$ 297				
	<input type="checkbox"/> W12"xD12" (PD1212)	E2603 \$ 297				
	<input type="checkbox"/> W14"xD14" (PD1414)	E2603 \$ 297				
	<input type="checkbox"/> Extra Sensitive (\$35 up charge) <input type="checkbox"/> Sling Style Bottom (\$52 up charge) <input type="checkbox"/> Custom Size W(") x D(") (\$- CFP)						
ROHO WHEELCHAIR CUSHIONS							
Choose Size	<input type="checkbox"/> 4" HIGH PROFILE® QUADTRO SELECT® CUSHION *Black Upholstery		<input type="checkbox"/> Extra Cover (\$+57) only E2622-2623 \$ 582				
	<input type="checkbox"/> W12"xD12"	<input type="checkbox"/> W12"xD13"	<input type="checkbox"/> W13"xD13"				
	<input type="checkbox"/> W15"xD16"	<input type="checkbox"/> W15"xD18"	<input type="checkbox"/> W16"xD15"				
	<input type="checkbox"/> W18"xD16"	<input type="checkbox"/> W18"xD18"	<input type="checkbox"/> W18"xD20"				
	<input type="checkbox"/> W20"xD22"	<input type="checkbox"/> W22"xD18"	<input type="checkbox"/> W22"xD20"				
Choose Size	<input type="checkbox"/> 3" MID PROFILE® QUADTRO SELECT® CUSHION *Black Upholstery only		<input type="checkbox"/> Extra Cover E2622-2623 \$ 582				
	<input type="checkbox"/> W15"xD15"	<input type="checkbox"/> W15"xD16"	<input type="checkbox"/> W16"xD16"				
	<input type="checkbox"/> W16"xD16"	<input type="checkbox"/> W16"xD18"	<input type="checkbox"/> W18"xD16"				
	<input type="checkbox"/> W18"xD16"	<input type="checkbox"/> W18"xD18"	<input type="checkbox"/> W18"xD18"				
	<input type="checkbox"/> Custom Size W(") x D(") (\$+CFP)						
Choose Size	<input type="checkbox"/> 2" LOW PROFILE® QUADTRO SELECT® CUSHION *Black Upholstery only		<input type="checkbox"/> Extra Cover (\$+57) E2622-2623 \$ 582				
	<input type="checkbox"/> W12"xD12"	<input type="checkbox"/> W12"xD13"	<input type="checkbox"/> W13"xD13"				
	<input type="checkbox"/> W15"xD16"	<input type="checkbox"/> W15"xD18"	<input type="checkbox"/> W16"xD15"				
	<input type="checkbox"/> W18"xD16"	<input type="checkbox"/> W18"xD18"	<input type="checkbox"/> W18"xD20"				
	<input type="checkbox"/> Custom Size W(") x D(") (\$+CFP)						
STAR CUSHIONS							
Galaxy Cushion *Black Upholstery only <input type="checkbox"/> W14"xD14" (GXY 1414-2) <input type="checkbox"/> W16"xD14" (GXY 1614-2) <input type="checkbox"/> W16"xD18" (GXY 1618-2) <input type="checkbox"/> W18"xD18" (GXY 1818-2) <input type="checkbox"/> W20"xD16" (GXY 2016-2) <input type="checkbox"/> W20"xD20" (GXY 2020-2)	<input type="checkbox"/> W14"xD16" (GXY 1416-2) <input type="checkbox"/> W16"xD16" (GXY 1616-2) <input type="checkbox"/> W18"xD16" (GXY 1816-2) <input type="checkbox"/> W18"xD20" (GXY 1820-2) <input type="checkbox"/> W20"xD18" (GXY 2018-2)	➔	Choose Zoning Options E2624 \$ CFP				
			<input type="checkbox"/> Standard - Dual Valve				
			<input type="checkbox"/> Dual Valve - Front to Back				
			<input type="checkbox"/> Four Valve				
			<input type="checkbox"/> Simple - Single Valve				
			<input type="checkbox"/> Four Valve - Enhanced				
			<input type="checkbox"/> Four Valve - Front to Back				
THE CURVE CUSHION *Black Upholstery only <input type="checkbox"/> Extra Cover (\$+ 40)	<input type="checkbox"/> W10"xD10"	<input type="checkbox"/> W10"xD11"	<input type="checkbox"/> W10"xD11"	<input type="checkbox"/> W10"xD12"	<input type="checkbox"/> W11"xD12"	<input type="checkbox"/> W12"xD12"	\$ 127
	<input type="checkbox"/> W12"xD13"	<input type="checkbox"/> W12"xD14"	<input type="checkbox"/> W13"xD11"	<input type="checkbox"/> W13"xD12"	<input type="checkbox"/> W13"xD13"	<input type="checkbox"/> W13"xD14"	
	<input type="checkbox"/> W14"xD14"	<input type="checkbox"/> W14"xD15"	<input type="checkbox"/> W14"xD16"	<input type="checkbox"/> W15"xD14"	<input type="checkbox"/> W15"xD15"	<input type="checkbox"/> W15"xD16"	
	<input type="checkbox"/> W16"xD14"	<input type="checkbox"/> W16"xD15"	<input type="checkbox"/> W16"xD16"	<input type="checkbox"/> W16"xD17"	<input type="checkbox"/> W16"xD18"	<input type="checkbox"/> W17"xD16"	
	<input type="checkbox"/> W17"xD17"	<input type="checkbox"/> W17"xD18"	<input type="checkbox"/> W18"xD16"	<input type="checkbox"/> W18"xD17"	<input type="checkbox"/> W18"xD18"		

Valid from 2022 Prices & Specifications Are Subject To Change Without

E CHAIR OPTIONS 2 / 3

SEAT CUSHION			
Exgel Kaji Cushion			
For Comfortable Sitting To Prevent Pressure Sores			
<input type="checkbox"/> Owl Regular(1.6" Thick) Incontinence Cover Only	<input type="checkbox"/> W14"xD16"	E2603 \$ 362
	<input type="checkbox"/> W15"xD16"	E2603 \$ 362
	<input type="checkbox"/> W16"xD16"	E2603 \$ 362
	<input type="checkbox"/> W18"xD16" * No Custom Sizes	E2603 \$ 408
<input type="checkbox"/> Owl High(3.1" Thick) Incontinence Cover Only	<input type="checkbox"/> W14"xD16"	E2603 \$ 437
	<input type="checkbox"/> W15"xD16"	E2603 \$ 437
	<input type="checkbox"/> W16"xD16"	E2603 \$ 437
	<input type="checkbox"/> W18"xD16"	E2603 \$ 495
	<input type="checkbox"/> W18"xD18" * No Custom Sizes	E2603 \$ 495
<input type="checkbox"/> Owl Contour(4.3" Thick) Incontinence Cover Only	<input type="checkbox"/> W14"xD16"	E2603 \$ 454
	<input type="checkbox"/> W15"xD16"	E2603 \$ 454
	<input type="checkbox"/> W16"xD16"	E2603 \$ 454
	<input type="checkbox"/> W18"xD16"	E2603 \$ 495
* No Custom Sizes			
<input type="checkbox"/> Owl Deep Contour(4.3" Thick) <input type="checkbox"/> W14"xD16" \$ 458		* No Custom Sizes- Incontinence Cover Only	
<input type="checkbox"/> W14"xD16" \$518 <input type="checkbox"/> W15"xD16" \$518 <input type="checkbox"/> W16"xD16" \$518 <input type="checkbox"/> W18"xD16" \$558			
<input type="checkbox"/> Standard Regular(1.4" Thick) Easy to Use Flat Style (superior pressure redistribution)		<input type="checkbox"/> For Pressure E2622-2623	
<input type="checkbox"/> W12" x D12" \$368	<input type="checkbox"/> W13" x D13" \$368	<input type="checkbox"/> W14" x D14" \$368	<input type="checkbox"/> W14" x D16" \$368
<input type="checkbox"/> W16" x D17" \$368	<input type="checkbox"/> W17" x D16" \$368	<input type="checkbox"/> W17" x D17" \$368	<input type="checkbox"/> W18" x D16" \$391
<input type="checkbox"/> W18" x D19" \$440	<input type="checkbox"/> W18" x D20" \$440	<input type="checkbox"/> W19" x D19" \$440	<input type="checkbox"/> W18" x D18" \$391
* No Custom Sizes- Incontinence Cover Only			
<input type="checkbox"/> Standard High(2.6" Thick) Incontinence Cover Only		E2622	
*Black Upholstery only			
<input type="checkbox"/> W12" x D12" \$383	<input type="checkbox"/> W13" x D13" \$ 383	<input type="checkbox"/> W14" x D14" \$383	<input type="checkbox"/> W14" x D16" \$ 383
<input type="checkbox"/> W16" x D17" \$383	<input type="checkbox"/> W17" x D16" \$383	<input type="checkbox"/> W17" x D17" \$383	<input type="checkbox"/> W18" x D16" \$460
<input type="checkbox"/> W18" x D19" \$512	<input type="checkbox"/> W18" x D20" \$512	<input type="checkbox"/> W19" x D19" \$512	<input type="checkbox"/> W18" x D18" \$460
<input type="checkbox"/> W18" x D19" \$512	<input type="checkbox"/> W18" x D20" \$512	<input type="checkbox"/> W19" x D19" \$512	<input type="checkbox"/> W18" x D19" \$512
<input type="checkbox"/> Standard Anti-Thrust(2.6" Thick) * No Custom Sizes Incontinence Cover Only	<input type="checkbox"/> W16 x D16 \$460	Prevents Unwanted Forward Movement of lower back and hip bone	
	<input type="checkbox"/> W18 x D16 \$500		
	<input type="checkbox"/> W18 x D18 \$500		
<input type="checkbox"/> Lite Regular(2.2" Thick) <input type="checkbox"/> W16" x D16" \$374 <input type="checkbox"/> W18" x D16" \$397 <input type="checkbox"/> W18" x D18" \$397		* No Custom Sizes- Incontinence Cover Only	
<input type="checkbox"/> Lite High(3.0" Thick) <input type="checkbox"/> W16" x D16" \$408 <input type="checkbox"/> W18" x D16" \$431 <input type="checkbox"/> W18" x D18" \$431		* No Custom Sizes- Incontinence Cover Only	

F CHAIR OPTIONS 3/3

POSITIONING BACK

***Note : Actual height of the backrest will increase 2" or more.**

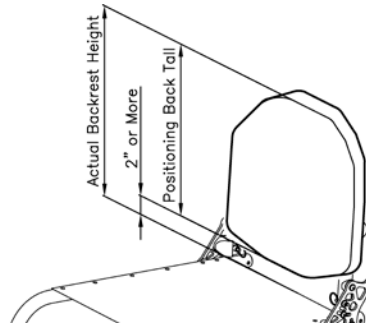

ADI CARBON BACKREST (Support Contour-ACTIVE 2.5") *Not Available with Welded Side Guards

Mounting Hardware: 2 Point Pro Quick Release

<input type="checkbox"/> Add Privacy Flap (\$69 up charge)	Height	<input type="checkbox"/> LOW (10" Tall) *Backrest Height requires 12" or more *Available 13"-19" width	Width (")	E2613	\$ 857
		<input type="checkbox"/> Medium (13" Tall) *Backrest Height requires 15" or more *Available 13"-19" width	Width (")	E2613	\$ 937
		<input type="checkbox"/> Standard (16" Tall) *Backrest Height requires 18" or more *Available 13"-19" width	Width (")	E2613	\$1,012
		<input type="checkbox"/> Custom Size (" Tall) x (" width)		E2613	\$ CFP

ADI ALUMINUM BACKREST (Support Contour-ACTIVE 2.5") *Not Available with Welded Side Guards

Mounting Hardware: 2 Point Pro Quick Release

<input type="checkbox"/> Add Privacy Flap (\$69 up charge)	Height	<input type="checkbox"/> LOW (10" Tall) *Backrest Height requires 12" or more *Available 10"-20" width	Width (")	E2613	\$ 702
		<input type="checkbox"/> Medium (13" Tall) *Backrest Height requires 15" or more *Available 12"-20" width	Width (")	E2613	\$ 719
		<input type="checkbox"/> Standard (16" Tall) *Backrest Height requires 18" or more *Available 14"-20" width	Width (")	E2613	\$ 736
		<input type="checkbox"/> Tall (18" Tall) *Backrest Height requires 20" or more *Available 16"-20" width	Width (")	E2613	\$ 753
		<input type="checkbox"/> X-Tall (20" Tall) *Backrest Height requires 22" or more *Available 16"-20" width	Width (")	E2613	\$ 570
		<input type="checkbox"/> Custom Size (" Tall) x (" width)		E2613	\$ CFP

ADI ALUMINUM BACKREST (Support Contour-DEEP 4") *Not Available with Welded Side Guards*Not Available with Lateral Supports

Mounting Hardware: 2 Point Pro Quick Release

<input type="checkbox"/> Add Privacy Flap (\$69 up charge)	Height	<input type="checkbox"/> LOW (10" Tall) *Backrest Height requires 12" or more *Available 10"-20" width	Width (")	E2615	\$ 817
		<input type="checkbox"/> Medium (13" Tall) *Backrest Height requires 15" or more *Available 12"-20" width	Width (")	E2615	\$ 834
		<input type="checkbox"/> Standard (16" Tall) *Backrest Height requires 18" or more *Available 14"-20" width	Width (")	E2615	\$ 851
		<input type="checkbox"/> Tall (18" Tall) *Backrest Height requires 20" or more *Available 16"-20" width	Width (")	E2615	\$ 868
		<input type="checkbox"/> X-Tall (20" Tall) *Backrest Height requires 22" or more *Available 16"-20" width	Width (")	E2615	\$ 886
		<input type="checkbox"/> Custom Size (" Tall) x (" width)		E2615	\$ CFP

ADI LATERAL SUPPORTS (Lateral Supports are compatible with only active 2.5" ADI positioning back.)

Stationary Pad Pad Size Small (3" H x 3" D) Medium(3" H x 4" D) Large(4.5" H x 4.5" D) Large(4" H x 6" D)

<input type="checkbox"/> Pair	\$ 368
<input type="checkbox"/> Left side only or <input type="checkbox"/> Right side only	\$ 184

Swing-Out Pad Size Small (3" H x 3" D) Medium(3" H x 4" D) Large(4.5" H x 4.5" D) Large(4" H x 6" D)

<input type="checkbox"/> Pair	\$ 598
<input type="checkbox"/> Left side only or <input type="checkbox"/> Right side only	\$ 299

OTHER

<input type="checkbox"/> ADI Transfer Board <input type="checkbox"/> 21" (ADV21) <input type="checkbox"/> 24" (ADV24) <input type="checkbox"/> 29" (ADV29)	\$ 71
<input type="checkbox"/> ADI Push and Transfer Gloves Leather (one size fits)	\$ 69
<input type="checkbox"/> ADI Carbon Solid Seat (Wide: 18" Max, Depth: 20") ✖ ONLY AVAILABLE WITH COLOURS NON-REMOVABLE SIDE GUARDS	\$ 719

VARILITE® Seating Systems Available

Please visit for all options. www.varilite.com CFP

NOTE